



Description

The 20KPA Series is designed specifically to protect sensitive electronic equipment from voltage transients induced by lightning and other transient voltage events.

Applications

- Communication Equipment
- Security & Protection
- Industrial Control Equipment
- Power Supply
- Automotive Electronics
- New Energy
- Lightning Protection

Functional Diagram

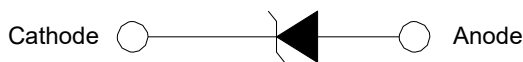

Uni-Directional



Bi-Directional

Features

- 20 kW peak pulse capability at 10/1000 μ s waveform, repetition rate (duty cycles):0.01%
- Glass passivated chip junction in P600 Package
- Fast response time: typically less than 1.0 PS from 0 Volts to BV min
- Excellent clamping capability
- Typical failure mode is short from over-specified voltage or current
- Whisker test is conducted based on JEDEC JESD201A per its table 4a and 4c
- IEC 61000-4-2 ESD 30 kV (Air), 30 kV (Contact)
- ESD protection of data lines in accordance with IEC 61000-4-2
- EFT protection of data lines in accordance with IEC 61000-4-4
- Low incremental surge resistance
- Typical $I_R \leq 2 \mu A$ when $V_{BR \text{ min}} > 49 V$
- High temperature to reflow soldering guaranteed: 260 °C/40 sec / 0.375", (9.5 mm) lead length, 5 lbs., (2.3 kg) tension
- $V_{BR} @ T_J = V_{BR@25^\circ C} \times (1 + \alpha T \times (T_J - 25))$
(αT : Temperature Coefficient, typical value is 0.1%)
- UL Recognized compound meeting flammability rating V-0
- Matte tin lead-free plated
- Halogen free and RoHS compliant
- Pb-free E3 indicates that 2nd level interconnect is Pb-free and the terminal finish material is tin(Sn) (IPC/ JEDEC J-STD-609A.01)

Package Outline Dimensions (P600)

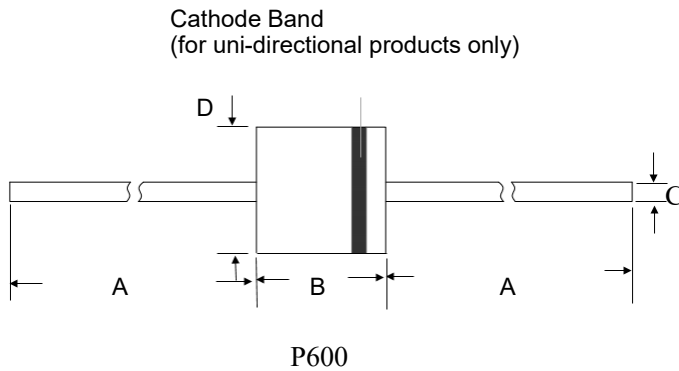

Symbol	Millimeters		Inches	
	Min.	Max.	Min.	Max.
A	25.40	-	1.000	-
B	8.60	9.10	0.340	0.360
C	1.22	1.36	0.048	0.054
D	8.60	9.10	0.340	0.360

Maximum Ratings and Characteristics

($T_A = 25\text{ }^\circ\text{C}$ unless otherwise specified.)

Parameter	Symbol	Value	Unit
Peak Pulse Power Dissipation by 10/1000 μs Test Waveform (Fig.2)(Note 1)	P_{PPM}	20	kW
Steady State Power Dissipation on Infinite Heat Sink at $T_L=75\text{ }^\circ\text{C}$	P_D	8.0	W
Peak Forward Surge Current, 8.3 ms Single Half Sine Wave Unidirectional Only (Note 2)	I_{FSM}	400	A
Operating Junction and Storage Temperature Range	T_J, T_{STG}	-55 to 175	$^\circ\text{C}$
Typical Thermal Resistance Junction to Lead	$R_{\theta JL}$	8.0	$^\circ\text{C/W}$
Typical Thermal Resistance Junction to Ambient	$R_{\theta JA}$	40	$^\circ\text{C/W}$

Notes:

1. Non-repetitive current pulse, per Fig. 4 and derated above $T_J(\text{initial})=25\text{ }^\circ\text{C}$ per Fig. 3.
2. Measured of 8.3 ms single half sine-wave or equivalent square wave, duty cycle=4 per minute maximum.

Part Numbering System

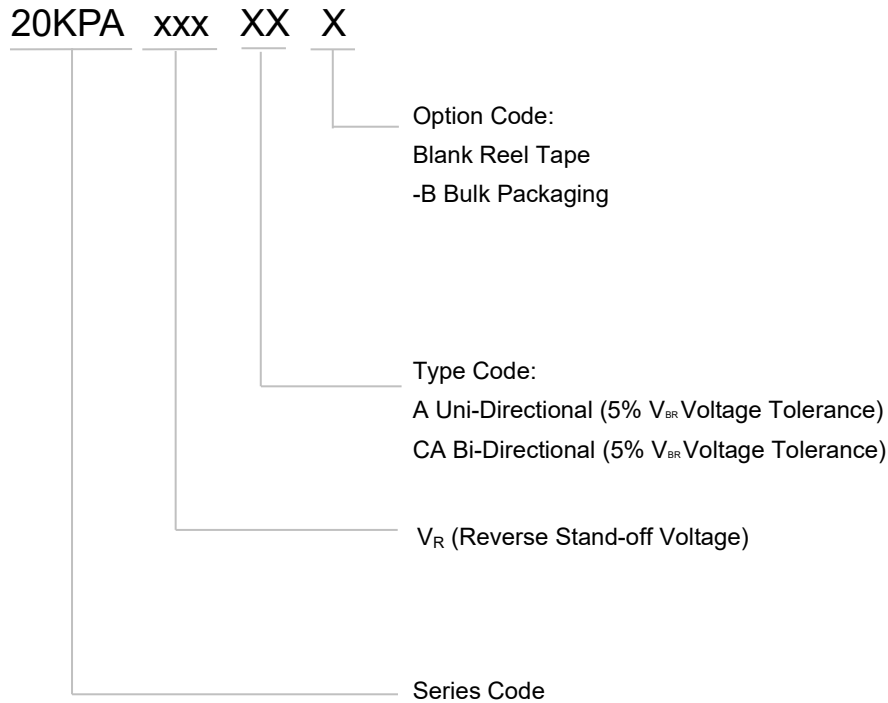

Marking

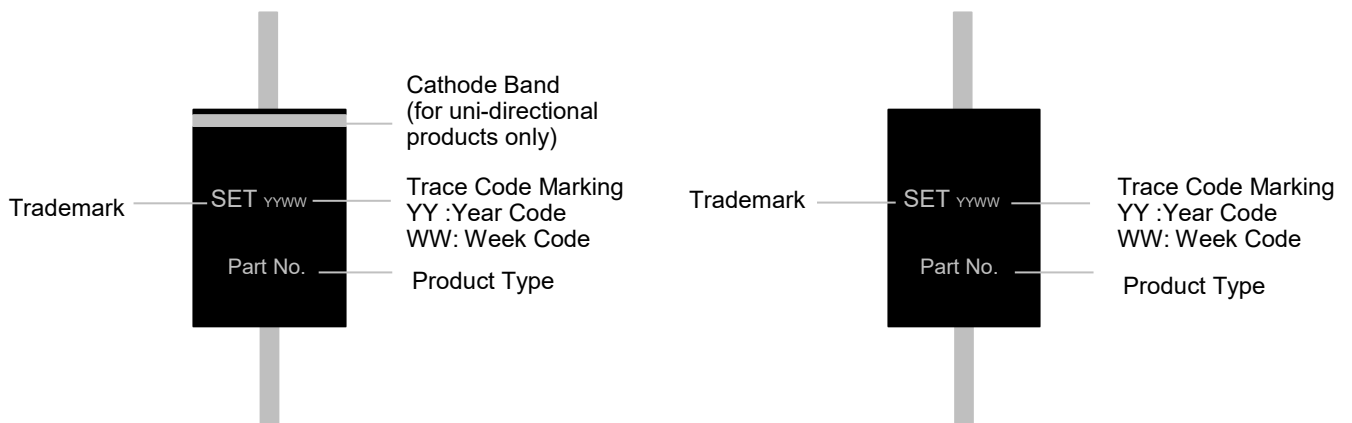

Electrical Characteristics (T_A=25 °C unless otherwise noted)

Part Number		Breakdown Voltage V _{BR@I_T}		Test Current I _T	Reverse Stand-off Voltage V _R	Max. Reverse Leakage I _{R@V_R}	Max. Peak Pulse Current I _{PPM}	Max. Clamping Voltage V _{C@I_{PPM}}
		Min	Max					
Uni	Bi	(V)		(mA)	(V)	(μA)	(A)	(V)
20KPA20A	20KPA20CA	22.34	24.57	50	20.00	5000.00	548.90	36.80
20KPA24A	20KPA24CA	26.81	29.49	50	24.00	5000.00	490.30	41.20
20KPA26A	20KPA26CA	29.04	31.94	50	26.00	2000.00	451.90	44.70
20KPA28A	20KPA28CA	31.28	34.41	50	28.00	1000.00	420.80	48.00
20KPA30A	20KPA30CA	33.51	36.86	5	30.00	250.00	392.20	51.50
20KPA32A	20KPA32CA	35.74	39.31	5	32.00	150.00	372.00	54.30
20KPA34A	20KPA34CA	38.00	41.80	5	34.00	50.00	351.30	57.50
20KPA36A	20KPA36CA	40.20	44.22	5	36.00	20.00	328.50	61.50
20KPA40A	20KPA40CA	44.70	49.17	5	40.00	15.00	297.90	67.80
20KPA44A	20KPA44CA	49.10	54.01	5	44.00	2.00	277.90	72.70
20KPA48A	20KPA48CA	53.60	58.96	5	48.00	2.00	254.40	79.40
20KPA52A	20KPA52CA	58.10	63.91	5	52.00	2.00	235.40	85.80
20KPA56A	20KPA56CA	62.60	68.86	5	56.00	2.00	218.10	92.60
20KPA60A	20KPA60CA	67.00	73.70	5	60.00	2.00	207.00	97.60
20KPA64A	20KPA64CA	71.50	78.65	5	64.00	2.00	194.20	104.00
20KPA68A	20KPA68CA	76.00	83.60	5	68.00	2.00	183.60	110.00
20KPA72A	20KPA72CA	80.40	88.44	5	72.00	2.00	174.10	116.00
20KPA80A	20KPA80CA	89.40	98.34	5	80.00	2.00	155.40	130.00
20KPA88A	20KPA88CA	98.30	108.13	5	88.00	2.00	142.30	142.00
20KPA96A	20KPA96CA	107.20	117.92	5	96.00	2.00	130.30	155.00
20KPA104A	20KPA104CA	116.20	127.82	5	104.00	2.00	120.20	168.00
20KPA112A	20KPA112CA	125.10	137.61	5	112.00	2.00	111.00	182.00
20KPA120A	20KPA120CA	134.00	147.40	5	120.00	2.00	104.10	194.00
20KPA132A	20KPA132CA	147.40	162.14	5	132.00	2.00	94.80	213.00
20KPA144A	20KPA144CA	160.80	176.88	5	144.00	2.00	87.10	232.00

Part Number		Breakdown Voltage $V_{BR@I_T}$		Test Current I_T	Reverse Stand-off Voltage V_R	Max. Reverse Leakage $I_R@V_R$	Max. Peak Pulse Current I_{PPM}	Max. Clamping Voltage $V_C@I_{PPM}$
		Min	Max					
Uni	Bi	(V)		(mA)	(V)	(μ A)	(A)	(V)
20KPA160A	20KPA160CA	178.70	196.57	5	160.00	2.00	78.30	258.00
20KPA172A	20KPA172CA	192.10	211.31	5	172.00	2.00	72.90	277.00
20KPA180A	20KPA180CA	201.10	221.21	5	180.00	2.00	69.40	291.00
20KPA192A	20KPA192CA	214.50	235.95	5	192.00	2.00	65.40	309.00
20KPA204A	20KPA204CA	227.90	250.69	5	204.00	2.00	61.40	329.00
20KPA216A	20KPA216CA	241.30	265.43	5	216.00	2.00	58.00	348.00
20KPA232A	20KPA232CA	259.10	285.01	5	232.00	2.00	54.00	374.00
20KPA240A	20KPA240CA	268.10	294.91	5	240.00	2.00	52.20	387.00
20KPA256A	20KPA256CA	286.00	314.60	5	256.00	2.00	49.00	412.00
20KPA280A	20KPA280CA	312.80	344.08	5	280.00	2.00	44.80	451.00
20KPA300A	20KPA300CA	335.10	368.61	5	300.00	2.00	41.80	483.00

Notes:

1. Measured of 8.3 ms single half sine-wave or equivalent square wave, duty cycle=4 pulses per minute maximum.
2. $V_F < 3.5$ V for single die parts and $V_F < 5.0$ V for stacked-die parts.
3. For bidirectional type having V_R of 40 volts and less, the I_R should be doubled.

I-V Curve Characteristics

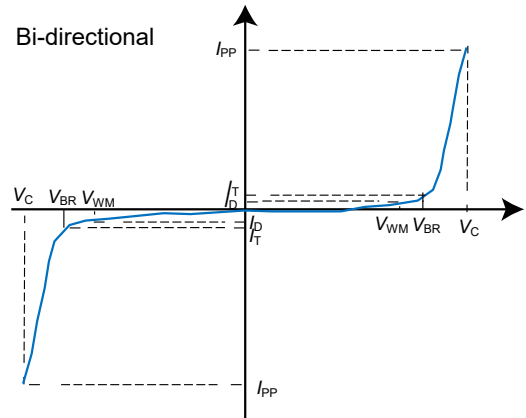
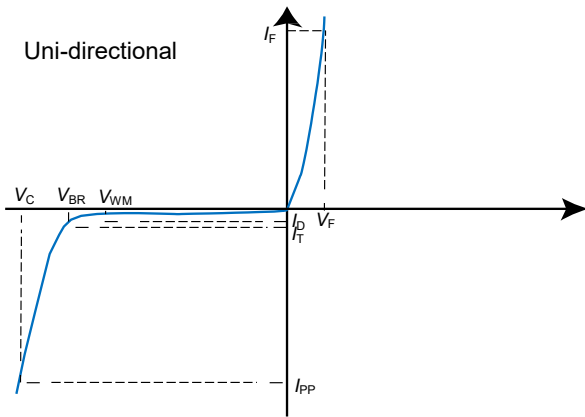

Performance Curve for Reference ($T_A=25^\circ\text{C}$ unless otherwise noted)

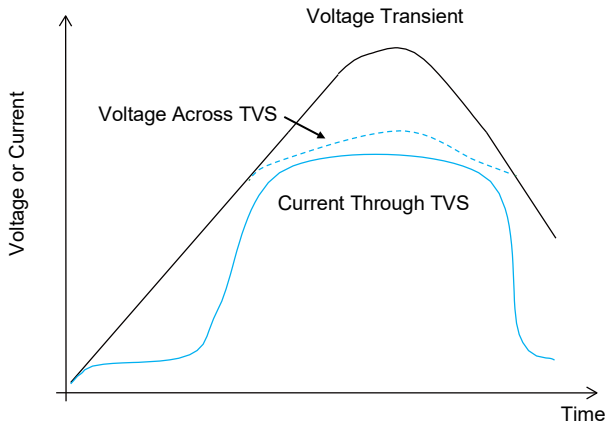

FIGURE 1 TVS Transients Clamping Waveform

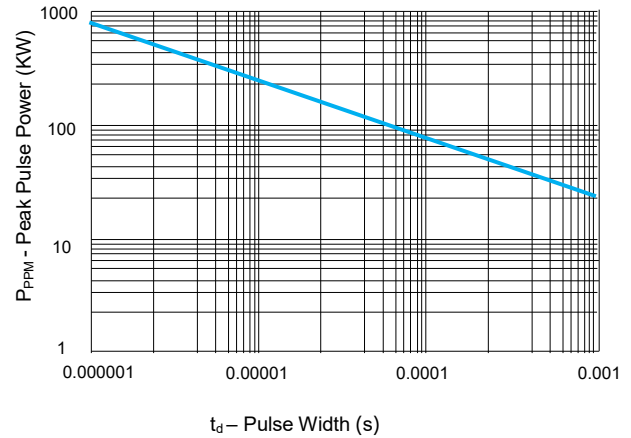

FIGURE 2 Peak Pulse Power Rating Curve

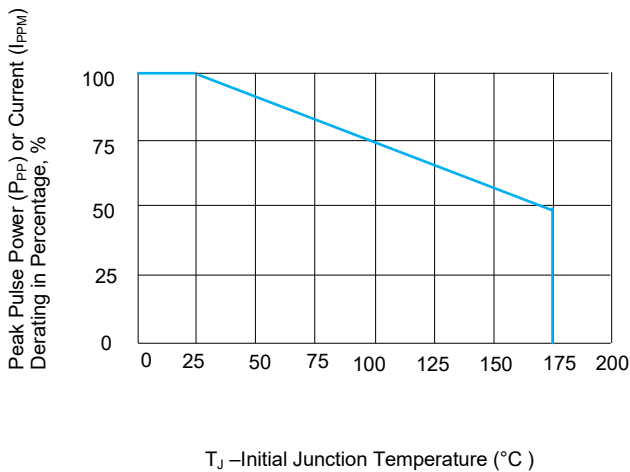

FIGURE 3 Peak Pulse Power Derating Curve

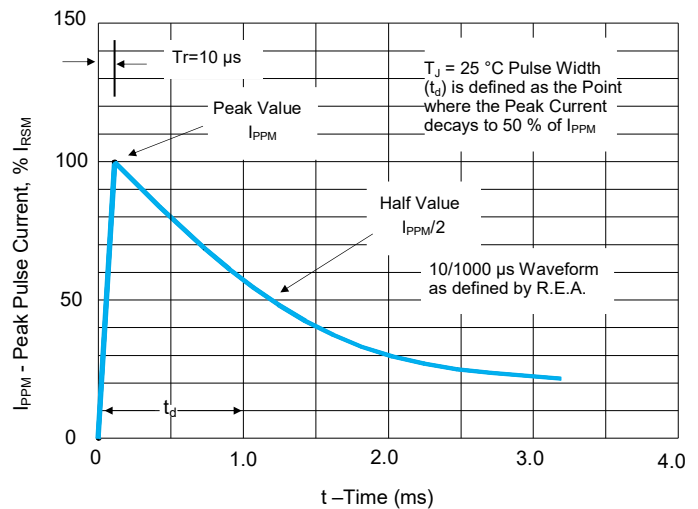

FIGURE 4 Pulse Waveform

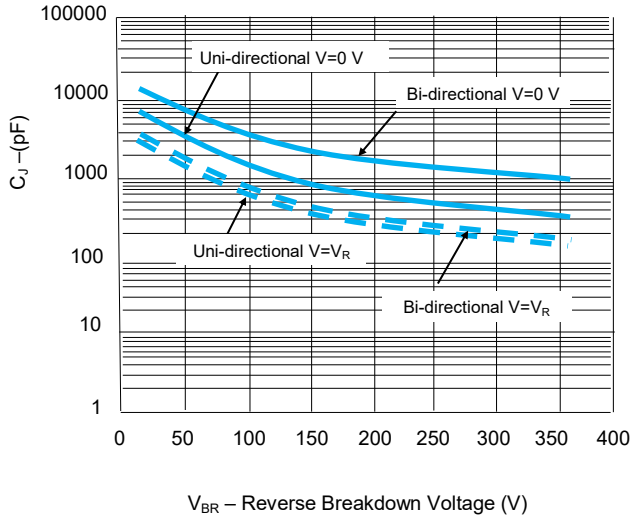

FIGURE 5 Typical Junction Capacitance

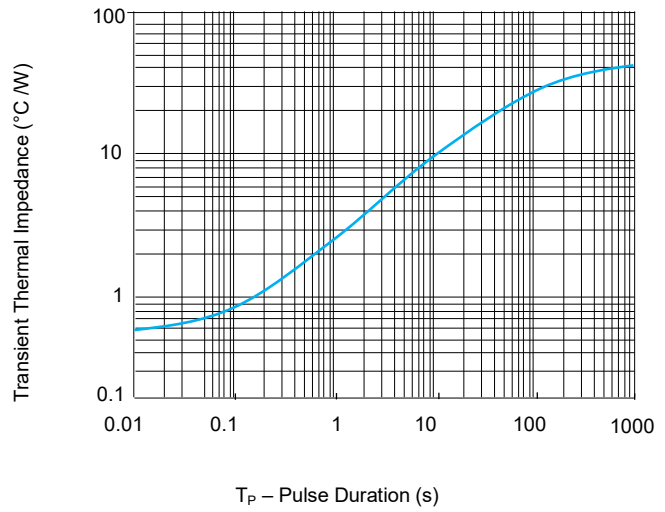

FIGURE 6 Typical Transient Thermal Impedance

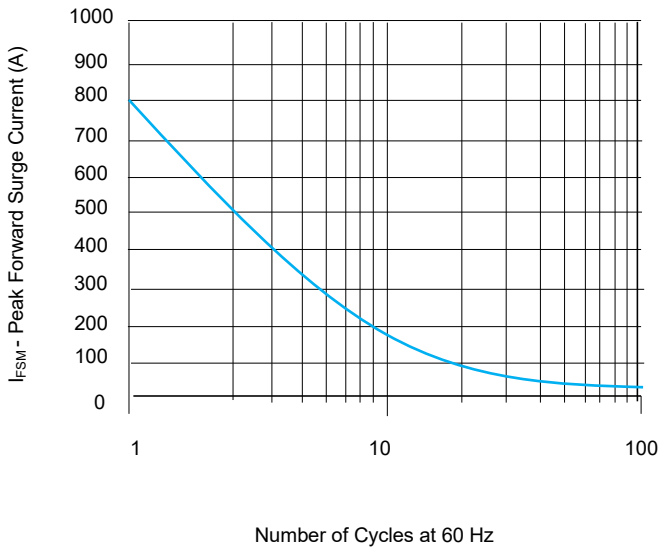

FIGURE 7 Maximum Non-Repetitive Forward Surge Current Uni-Directional only

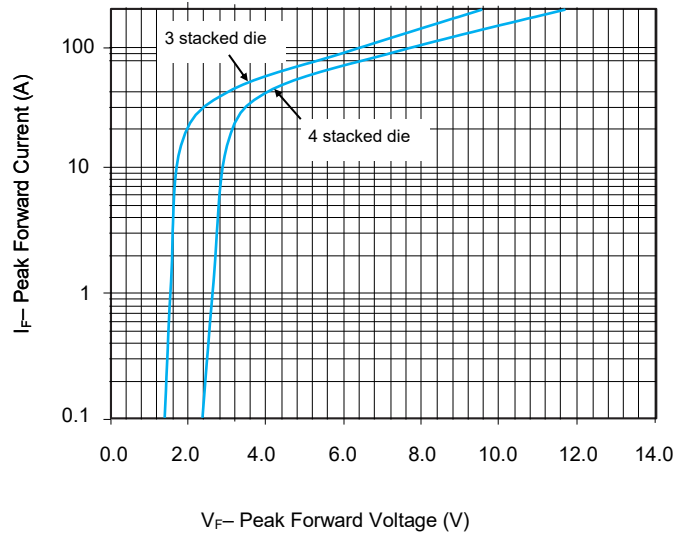

FIGURE 8 Peak Forward Drop vs Peak Forward Current (Typical Values)

Environmental Specifications

High Temp. Storage	JESD22-A103
HTRB	JESD22-A108
Temperature Cycling	JESD22-A104
H3TRB	JESD22-A101
RSH	JESD22-B106

Physical Specifications

Weight	0.07 oz., 2.5 g
Case	P600 molded plastic body over passivated junction.
Polarity	Color band denotes the cathode except Bipolar.
Terminal	Matte Tin axial leads, solderable per JESD22-B102.

Soldering Parameters

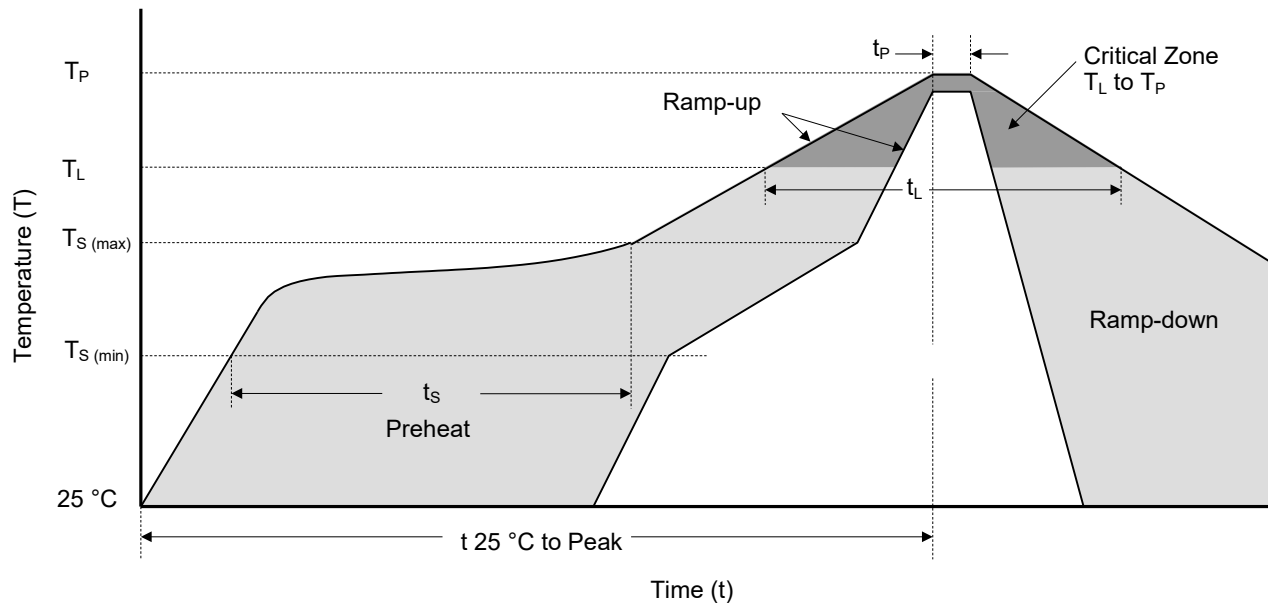

Reflowing Condition

Reflow Soldering Parameters		Lead-Free Assembly
Pre-heat	Temperature Min ($T_{S (min)}$)	150 °C
	Temperature Max ($T_{S (max)}$)	200 °C
	Time (min to max) (t_s)	60 ~ 120 seconds
Average Ramp Up Rate (Liquidus Temp (T_L) to Peak)		3 °C / second max.
$T_{S (max)}$ to T_L Ramp-up Rate		3 °C / second max.
Reflow	Temperature (T_L) (Liquidus)	217 °C
	Time (min to max) (t_L)	60 ~ 150 seconds
Peak Temperature (T_P)		260 ^{+0/-5} °C
Time of within 5 °C of Actual Peak Temperature (t_p)		20 ~ 40 seconds
Ramp-down Rate		6 °C / second max.
Time from 25 °C to Peak Temperature		8 Minutes max.
Do Not Exceed		260 °C

Flow/Wave Soldering (Solder Dipping)

Peak Temperature	260 °C+0 /- 5 °C
Dipping Time	10 seconds
Soldering Number	1 time

Packaging Information

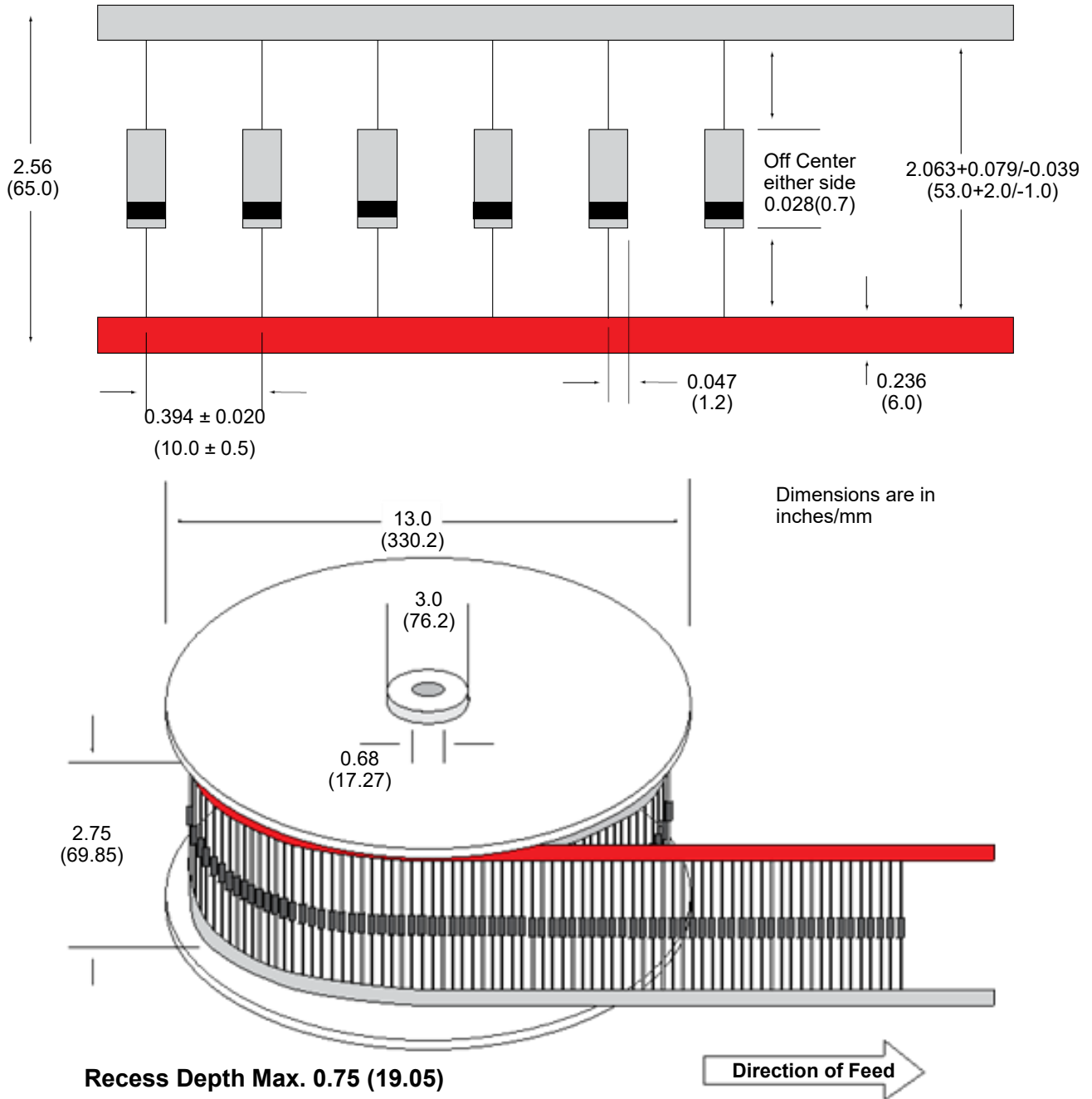

Part Number	Package	QTY' s (Reel)	Packaging Option	Packaging Specification
20KPAxxxXX	P600	800 PCS	Tape & Reel	EIA STD RS-296
20KPAxxxXX-TB	P600	300 PCS	TB	/
20KPAxxxXX-B	P600	100 PCS	BULK	SETsafe SETfuse Spec

Glossary

Item	Description
V_C	Clamping Voltage Voltage across TVS in a region of low differential resistance that serves to limit the voltage across the device terminals.
V_R	Reverse Stand-off Voltage Maximum voltage that can be applied to the TVS without operation. NOTE : It is also shown as V_{WM} (maximum working voltage (maximum d.c. voltage)) and known as rated stand-off voltage (V_{so}).
I_R	Reverse Leakage Current Current measured at V_R . NOTE : Also shown as I_D for stand-by current.
V_{BR}	Breakdown Voltage Voltage across TVS at a specified current I_T in the breakdown region.
I_{PPM}	Rated Random Recurring Peak Impulse Current Maximum-rated value of random recurring peak impulse current that may be applied to a device.
$P_{M(AV)}$	Rated Average Power Dissipation Maximum-rated value of power dissipation resulting from all sources, including transients and standby current, averaged over a short period of time.
P_{PPM}	Rated Random Recurring Peak Impulse Power Dissipation Maximum-rated value of the product of rated random recurring peak impulse current (I_{PPM}) multiplies by specified maximum clamping voltage (V_C).
C_J	Capacitance Capacitance across the TVS measured at a specified frequency and voltage.
V_{FS}	Peak Forward Surge Voltage Peak voltage across an TVS for a specified forward surge current (I_{FS}) and time duration. NOTE : Also shown as V_F .
I_{FS}	Forward Surge Current Pulsed current through TVS in the forward conducting region. NOTE : Also shown as I_F .
$\alpha_{V(BR)}$	Temperature Coefficient of Breakdown Voltage The change of breakdown voltage divided by the change of temperature.
I_{PP}	Peak pulse Current Peak pulse current value applied across the TVS to determine the clamping voltage V_C for a specified wave shape.
I_T	Pulsed D.C. Test Current Test current for measurement of the breakdown voltage V_{BR} . This is defined by the manufacturer and usually given in milliamperes with a pulse duration of less than 40 ms. NOTE : Also shown as I_{BR} .

—(GB-T 18802.321 / IEC 61643-321 / JESD210A)



ATTENTION

Usage

1. TVS must be operated in the specified ambient temp.
2. Do not clean the TVS with strong polar solvent such as ketone, esters, benzene and halogenated hydrocarbon, to avoid damaging the encapsulating layer.
3. Please do not apply severe vibration, shock or pressure to TVS, to avoid element cracking.

Replacement

1. If TVS is visually damaged, please replace it.
2. TVS is a non-repairable product. For safety sake, please use equivalent TVS for replacement.

Storage

1. Storage Temp. Range: (-55 to 150) °C.
2. Do not store the TVS at the high temp., high humidity or corrosive gas environment, to avoid influencing the solder- ability of the lead wires. The product shall be used up within 1 year after receiving the goods.

Environmental Conditions

1. TVS should not be exposed to the open air, nor direct sunshine.
2. TVS should avoid rain, water vapor or other condition of high temp. and high humidity.
3. TVS should avoid sand dust, salt mist, or other harmful gases.

Max. Typical Capacitance of TVS

The typical capacitance of TVS is listed in the specifications. Designers may refer to it when designing TVS in High frequency circuit.

Installation Mechanical Stress

1. Do not knock TVS when installing, to avoid mechanical damage.
2. Please do not apply severe vibration, shock or pressure to TVS, to avoid surface resin or element cracking.

Transient Voltage Suppressor (Surface Mount) Features Overview

Package Type						SMA6L				Series
DO-221AC	<input type="checkbox"/>	<input type="checkbox"/>	<input type="checkbox"/>	<input type="checkbox"/>	<input type="checkbox"/>	SMA6L	<input type="checkbox"/>	<input type="checkbox"/>	<input type="checkbox"/>	
DO-214AA	<input type="checkbox"/>	<input type="checkbox"/>	<input type="checkbox"/>	<input type="checkbox"/>	<input type="checkbox"/>	<input type="checkbox"/>	SACB	SMBJ	P6SMB	
DO-214AB	<input type="checkbox"/>	<input type="checkbox"/>	<input type="checkbox"/>	<input type="checkbox"/>	<input type="checkbox"/>	<input type="checkbox"/>	<input type="checkbox"/>	<input type="checkbox"/>	<input type="checkbox"/>	
DO-214AC	<input type="checkbox"/>	<input type="checkbox"/>	SMAJ	P4SMA	SMA6J	<input type="checkbox"/>	<input type="checkbox"/>	<input type="checkbox"/>	<input type="checkbox"/>	
SOD-123FL	SMF	P4SMF	<input type="checkbox"/>	<input type="checkbox"/>	<input type="checkbox"/>	<input type="checkbox"/>	<input type="checkbox"/>	<input type="checkbox"/>	<input type="checkbox"/>	
SMT0-218	<input type="checkbox"/>	<input type="checkbox"/>	<input type="checkbox"/>	<input type="checkbox"/>	<input type="checkbox"/>	<input type="checkbox"/>	<input type="checkbox"/>	<input type="checkbox"/>	<input type="checkbox"/>	
Product Outline (mm)										
V_R / V_{WM} (V) Reverse Stand-off Voltage	5.0 ~ 250	5.0 ~ 85	5.0 ~ 440	5.8 ~ 468	5.0 ~ 250	5.0 ~ 50	5.0 ~ 440	5.8 ~ 512		
P_{PPM} (W) (10/1000 μ s) Rated Peak ImPulse Power Dissipation	200		400		600	500		600		
I_{PPM} (kA)(8/20 μ s) Rated Peak ImPulse Current					<input type="checkbox"/>					
Operating Temperature (°C)	-55 to +150									

Transient Voltage Suppressor (Surface Mount) Features Overview

Package Type	Series									
	DO-221AC	DO-214AA	DO-214AB	DO-214AC	SOD-123FL	SMT0-218	SPC1	SPC3	SPC6	SPC10
	<input type="checkbox"/>	<input type="checkbox"/>	<input type="checkbox"/>	<input type="checkbox"/>	<input type="checkbox"/>	<input type="checkbox"/>	<input type="checkbox"/>	<input type="checkbox"/>	<input type="checkbox"/>	<input type="checkbox"/>
	<input type="checkbox"/>	<input type="checkbox"/>	<input type="checkbox"/>	<input type="checkbox"/>	<input type="checkbox"/>	<input type="checkbox"/>	<input type="checkbox"/>	<input type="checkbox"/>	<input type="checkbox"/>	<input type="checkbox"/>
	SMCJ	1.5SMC	3.0SMCJ	SMDJ	5.0SMDJ					
	<input type="checkbox"/>	<input type="checkbox"/>	<input type="checkbox"/>	<input type="checkbox"/>	<input type="checkbox"/>	<input type="checkbox"/>	<input type="checkbox"/>	<input type="checkbox"/>	<input type="checkbox"/>	<input type="checkbox"/>
	<input type="checkbox"/>	<input type="checkbox"/>	<input type="checkbox"/>	<input type="checkbox"/>	<input type="checkbox"/>	<input type="checkbox"/>	<input type="checkbox"/>	<input type="checkbox"/>	<input type="checkbox"/>	<input type="checkbox"/>
	<input type="checkbox"/>	<input type="checkbox"/>	<input type="checkbox"/>	<input type="checkbox"/>	<input type="checkbox"/>	<input type="checkbox"/>	SPC1	SPC3	SPC6	SPC10
Product Outline (mm)										
V_R / V_{WM} (V) Reverse Stand-off Voltage	5.0 ~ 440	5.8 ~ 512	5.0 ~ 440	12 ~ 170	380 / 430	66	58 ~ 76	58 ~ 86		
P_{PPM} (W) (10/1000 μ s) Rated Peak ImPulse Power Dissipation	1500	3000	5000							
I_{PPM} (kA)(8/20 μs) Rated Peak ImPulse Current						1	3	6	10	
Operating Temperature (°C)		-55 to +150					-55 to +125			

Transient Voltage Suppressor (Axial Lead) Features Overview

Package Type	Series																	
	DO-201	DO-41	DO-15	P600	Radial lead	1.5KE	LCE											
	○	○	○	○	○	○	○	○	○	○	○	○	○	○	○	○		
	P4KE	○	○	○	○	○	○	○	○	○	○	○	○	○	○	○		
	○	SAC	P6KE	○	○	○	○	○	○	○	○	○	○	○	○	○		
	○	○	○	○	○	○	○	5KP	15KPA	20KPA	30KPA	○	○	○	○	○		
	○	○	○	○	○	○	○	○	○	○	○	SPCL1	SPCL3	SPCL6	SPCL10	SPCL15	SPCL20	
Product Outline (mm)																		
V_R / V_{WM} (V) Reverse Stand-off Voltage	5.8 ~ 468	5.0 ~ 50	5.8 ~ 512	5.8 ~ 512	6.5 ~ 90	5.0 ~ 250	17 ~ 280	20 ~ 300	28 ~ 360	76	15 ~ 430	30 ~ 430	15 ~ 530	58 ~ 380	16 ~ 76			
P_{PPM} (W) (10/1000 μ s) Rated Peak ImPulse Power Dissipation	400	500	600	1500	5000	15000	20000	30000										○
I_{PPM} (kA)(8/20 μ s) Rated Peak ImPulse Current										1	3	6	10	15	20			
Operating Temperature (°C)										-55 to +150			-55 to +125					